

Serie: Gyng

Vare nr.:1039

Dato:13.8.2018

Aldersgruppe: 3+

Monteringstid:6 timer

Sikkerhedsareal:51 m2

Kræver faldunderlag:Ja

Faldhøjde: 150 cm

Samlet vægt:320kg

Største enkelt del:360cm



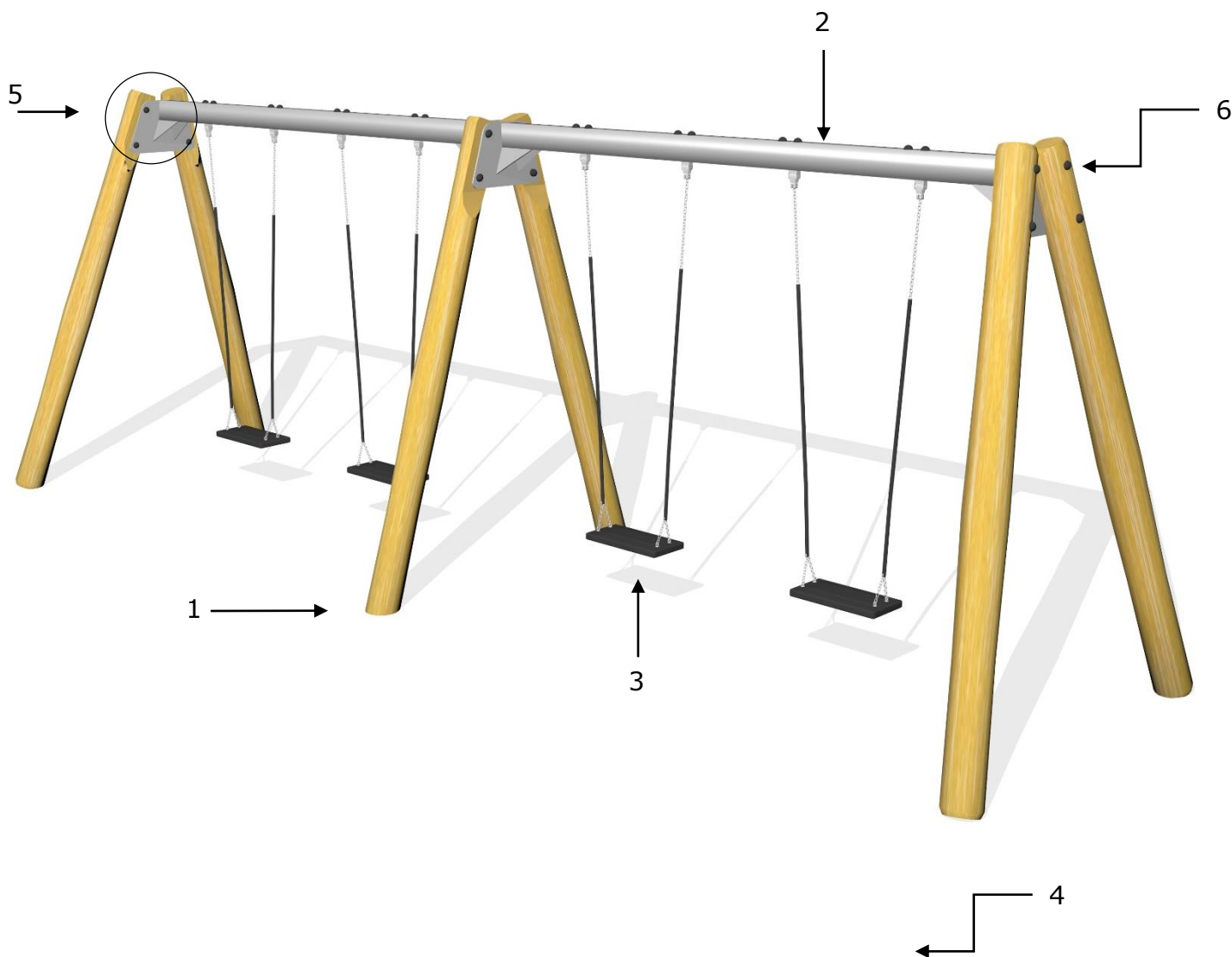





Vægt, største enkelt del:60 kg

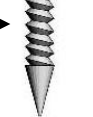

Stykliste:

Nr.:	Varenr.:	Beskrivelse	Dimension	Antal
1	ST 360	Robinia stolpe, tilskåret i top	Ø14-16 L=360cm	6
2	GVA 320	Overligger stål, med monterede beslag		2
3	GG	Gummigyngede, incl ophængning		4
4	FD F2	Fundering ST	se tegning FD F1	6
5	MPG	Montageprincip gyngede		2
6	PS	Producentstik	se tegning PS	1

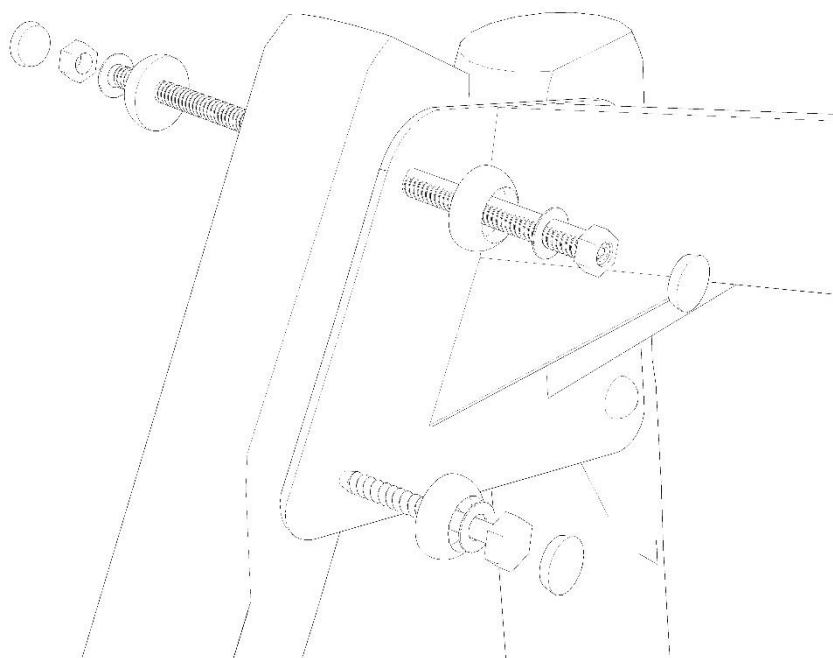
Serie: Gyngede	Vare nr.:1039	Dato:13.8.2018	Aldersgruppe: 3+
Monteringstid:6 timer	Sikkerhedsareal:51 m2	Kræver faldunderlag:Ja	Faldhøjde: 150 cm
Samlet vægt:320kg	Største enkelt-del:360cm	Vægt, største enkelt-del:60 kg	

Møtriks hus → Afslutningsprop → 16 mm skive → 
Møtrikshus → 16 mm
gevindstang
med påsvejs
møtrik → 
16 mm møtrik → Fransk skrue,
12X90 → Møtriks hus → 
Møtriks hus → 16 mm skive → 16 mm møtrik → Afslutningsprop → 